

**BATAVUS VA
HS 50**

**OWNER'S
MANUAL**



BATAVUS

code nr. 97-025

Printed in the Netherlands.

- 1 -

Batavus Mopeds are manufactured in Holland by the Batavus Intercycle Corporation which has long enjoyed an excellent reputation for quality and craftsmanship throughout the world.

To acquaint yourself with the outstanding features of the Batavus Mopeds we recommend that you read this owner's manual. The manual will give you details as to care and operation and enable you to maintain your moped in the best possible condition.

If you have any questions, please contact your local dealer who will be happy to assist you. We wish you many pleasant riding hours!

**ONLY THE TABLES MARKED:
"30 MPH VERSION" ON PAGES 2-3
AND 31-32 ARE APPLICABLE
TO THIS MOPED.**

Batavus USA, inc.
2546 N.E. Expressway
ATLANTA
Georgia 30345
Telephone (404) 325-1514

TECHNICAL DATA BATAVUS VA and HS50

	20 mph version	25 mph version	30 mph version
ENGINE			
Type	Laura M48, aircooled, fuel lubricated 2 stroke with reed valve induction directly into crank case		
Stroke	38 mm	38 mm	38 mm
Bore	40 mm	40 mm	40 mm
Cylinder capacity	48 cc	48 cc	48 cc
Electric unit	Bosch flywheel magneto with lighting coils 6V-22/5/10W		
Breaker gap	0.35 - 0.45 mm	0.35 - 0.45 mm	0.35 - 0.45 mm
Ignition	2.00-2.20 mm before TDC	2.00-2.20 mm before TDC	2.00-2.20 mm before TDC
Rupture distance	22-25 mm	22-25 mm	22-25 mm
Spark plug	Bosch 175 T 1	Bosch 175 T 1	Bosch W 240 T 1
Carburetor	Encarwi-Bing S 23	Encarwi-Bing S 8 A	Encarwi-Bing S 22/25
Jetsize			
(standard)	52	54	58
(after running in period eventually)	50	52	56

	20 mph version	25 mph version	30 mph version
Fuel	mixture of regular octane gas (not high octane!) and a good quality of corrosion resistant 2 stroke oil SAE 40		
Mixture proportion	during running in period: 1 : 40 (2.5 perc.), thereafter 1 : 50 (2 perc.)		

FRAME

Type	single tube frame		
Tank capacity	BATAVUS VA: .95 gal (3.5 l)	HS50	1.3 gal (5.0 l)
Tires	Michelin 2 - 16"	Michelin 2 - 16"	Michelin 2 - 16"
Tire pressure	frontwheel: 28 lbs rear wheel: 34 lbs		
Headlamp bulb	6V - 21W	6V - 21W	6V - 21W
Tail-light bulb	6V - 5W	6V - 5W	6V-5W
Brakelight bulb	6V - 10W	6V - 10W	6V - 10W

OPERATION OF BATAVUS VA — HS50

Operation of this moped is very simple, as you will see. With it's automatic clutch system, starting off only means twisting the throttle towards you; to slow down you only have to twist the throttle the other way. With the throttle backed off all the way, the engine will idle, and the clutch will disengage automatically. It's just as simple as that!

STARTING

Fill the fuel tank with the mixture as stated on page 2. During the first 500 miles (running in period) the fuel-mixture should be 40 : 1, thereafter 50 : 1. Refer to the information supplied on page 21 and 22 for fuel mixing.

Pull the engine kill switch on the handlebar (see Ill. 1) into position "RUN". Open the fuel valve by turning its lever into position "ON".

As you will notice, the fuel cock also has a reserve position; should the engine stop, due to lack of fuel, just turn the lever to position "RESERVE".

Now you will have enough fuel to reach the next gas station.

- | | |
|---------------------|------------------------|
| 1. rear brake lever | 5. engine kill switch |
| 2. start lever | 6. choke lever |
| 3. lighting switch | 7. front brake lever |
| 4. horn button | 8. throttle twist grip |

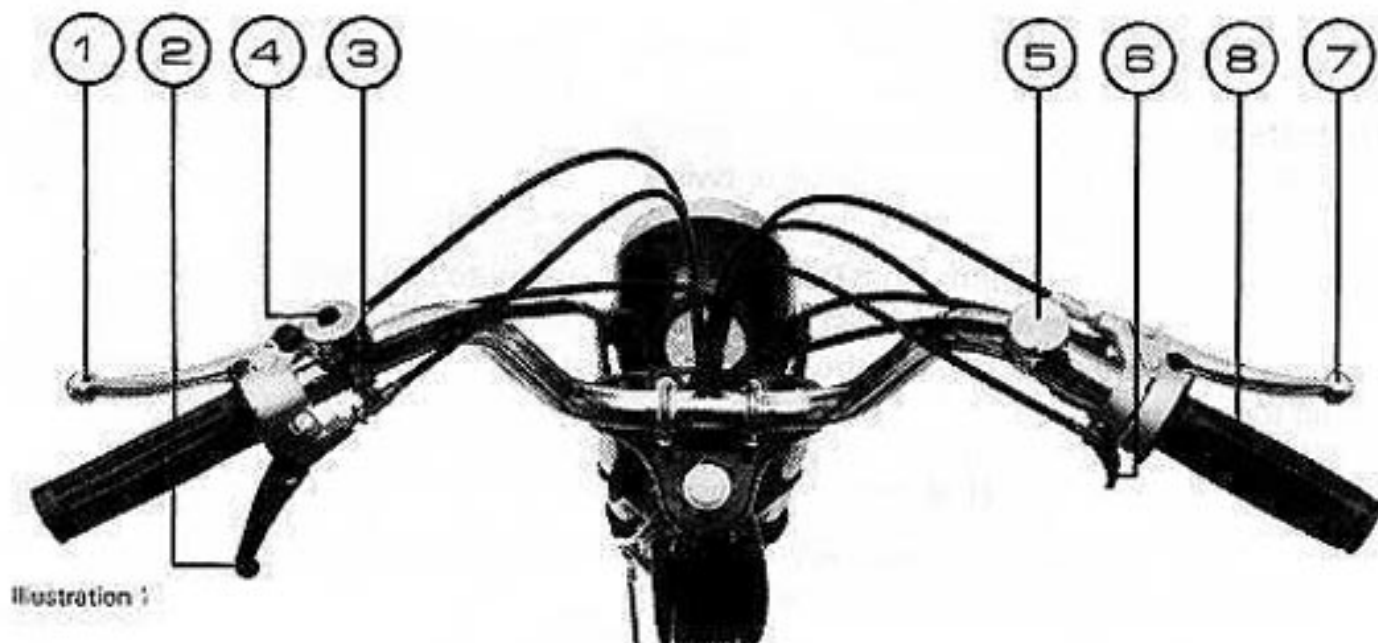

When finished driving, even for a few minutes, turn the fuel off. Move the fuel cock lever to position "OFF".

After having opened the fuel cock you can start as follows:

a) With cold engine

Pedal a few yards and then pull the start lever. At the same time press the small choke lever. As soon as the engine starts, release the start lever and twist the throttle. Keep the choke lever pressed during the first 20 - 30 seconds. If necessary, that is if the engine tends to cut out, re-choke once or twice.

b) With warm engine

When the engine is still warm from use it is not necessary to use the choke. Pedal a few yards, pull the start lever and twist the throttle open slightly as soon as the engine starts. At the same time release the start lever. Increase your speed by twisting the throttle towards you.

DRIVING

You will notice that your moped will accelerate quite quickly, which, particularly in town traffic, benefits your safety when passing.

Also the tractive power will surprise you; head-winds and normal road hills don't bother the Laura M48 engine. Please take this advice. If you are making a long distance trip, it is better not to drive with fully opened throttle continuously. Throttling down from time-to-time will increase the life of the engine considerably.

STOPPING

Practice stopping with either brake. Learn to use them together when stopping. When you have to stop due to traffic lights etc., you just close the throttle, by turning it away from you. The engine will continue to run at idle speed. To drive away again, you only have to open the throttle steadily. However, avoid running the engine for long periods when your moped is stationary. To stop the engine push the engine kill switch on the handlebar (see III. 1) into position "OFF". Close the fuel cock by turning the lever into position "OFF".

LIGHTS

To activate the driving lights, the engine must be running. Once the engine is running, simply operate the lighting switch on the handlebar (see III. 1).

RUNNING IN PERIOD

During the first 500 miles it is necessary to follow special instructions, which will help to extend the life of your moped's engine:

1. Start with a gas/oil mixture of 40 : 1 (see fuel mixture chart on page 22).
2. Avoid, especially during the first 100 miles, driving with full throttle. After these first 100 miles, it is advised to "play the throttle" now and then, that is throttle down occasionally when driving at full speed for long periods.
3. Also, avoid riding with a passenger or with heavy luggage during the running in period.
4. Don't change the jet during the running in period. The so called "four stroking", which may occur, may seem a little bit troublesome, but does not harm the engine at all; on the contrary, it gains extra lubrication in this way. Only when this "four stroking" still occurs frequently after the first 500 miles should a smaller jet be fitted. However, it is better to leave this decision to your dealer. An overly small jet will be harmful to the engine.

LUBRICATION AND MAINTENANCE SCHEDULE

MAINTENANCE OR LUBRICATION POINT	WHAT TO DO	Every 500 Miles	Every 1500 Miles	Every 2500 Miles
Carburetor	Clean and adjust (also see TECHNICAL SUPPLEMENTS pages 13 and 14)			X
Air filter	Depending on the degree of pollution to be washed out in petrol and then plunged into oil SAE 40 or 50 (squeeze out all excess oil),	X		
Engine and exhaust system	Decarbonize,		X	
Spark plug	Check, clean and adjust, or replace, (electrode gap has to be 0.5 mm),	X		

		Every 500 Miles	Every 1500 Miles	Every 2500 Miles
Chain	Grease and check tension, (Lubricant: thin engine oil; also see TECHNICAL SUPPLEMENTS page 17)	X		
Cables	Grease or oil,		X	
Hubs	Apply some oil drops to brake lever pivots, Pack bearings with new grease,	X		X
Spokes	Adjust tension after 250 and 1000 mls.			
Front fork	Provide with grease, preferably Retinax A, via greasing nipple (2 cc per forkleg),	X		

		Every 500 Miles	Every 1500 Miles	Every 2500 Miles
Steering Head and pedals	Remove and repack with new grease,			X
Speedometer drive	Provide with a little oil SAE 20 via greasing nipple,		X	
Bolts, nuts	Check if properly tightened,	X		
Pulley	Provide with grease via greasing nipple (remove superfluous grease),	X		
Crank axle bearings	These bearings are self-greasing; no maintenance is required.			

		Every 500 Miles	Every 1500 Miles	Every 2500 Miles
Swing axle bearings	These bearings are so called "silent blox"; no lubrication is required. Adjust swingaxle bolt tension after 500 mls.			
General remarks	Clean all greasing points before lubrication to prevent forcing in dust.			

TECHNICAL SUPPLEMENTS

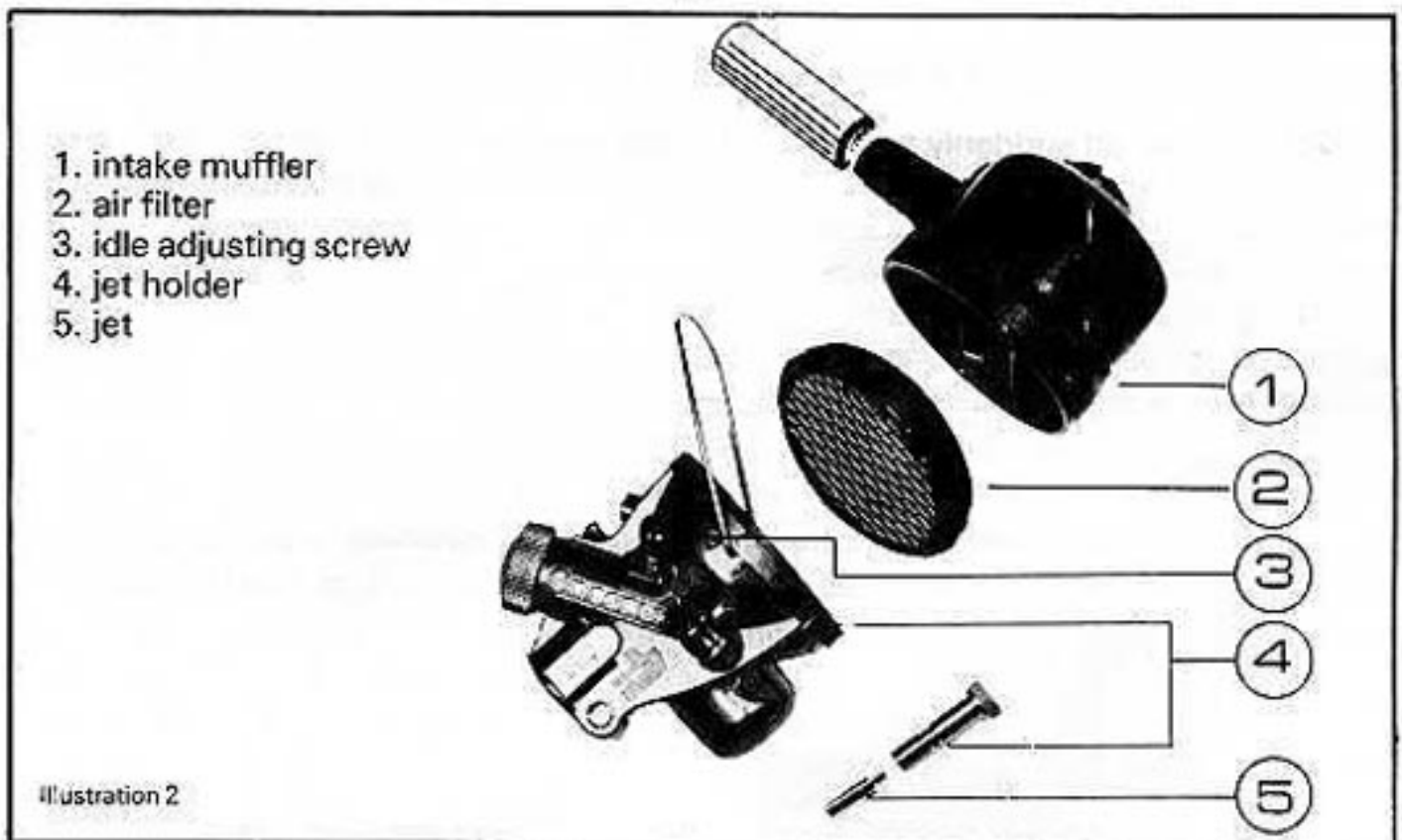

Carburetor (see III.2)

Only a properly adjusted carburetor guarantees real fuel economy.

Should the main jet suddenly be blocked (which can hardly ever happen, as fuel cock and carburetor are equipped with a filter), the jet holder can be removed by means of a screwdriver. Screw out the jet and blow through it thoroughly. Use a handpump if necessary, but never an iron wire, needle or anything similar! Having cleaned and oiled the air filter (every 500 miles), take care that the intake muffler is fixed in such a way, that the plastic tube points upwards. If pointed downwards dust will be sucked into the carburetor, causing wear on the engine parts.

Reed valve

The reed valve has to be taken care of by occasional cleaning in petrol with a soft brush. This ensures that dust does not prevent the valve springs lying perfectly flat against their respective surfaces on the housing.

Saddle

The square saddle post of the **BATAVUS VA** and the **HS50** must be tightened by 4 fastening bolts at all times.

The slot in the saddle post should not stick out of the saddle lug more than $1\frac{1}{4}$ " (abt. $1\frac{1}{4}$ "') (see III. 3).



Illustration 3

Adjustment of start cable

The start cable should have a movement of $3/16''$ (abt. 5 mm), measured from the start lever to the body (see Ill. 4). This movement can be adjusted by the adjuster on the lever body. To be completely on the safe side it is advised to remove the left side engine cover in order to check if the clutch lever has clearance to the thrust piece of the automatic clutch, when the start lever is not engaged. If not adjusted correctly, extra wear and tear of the clutch mechanism will result.

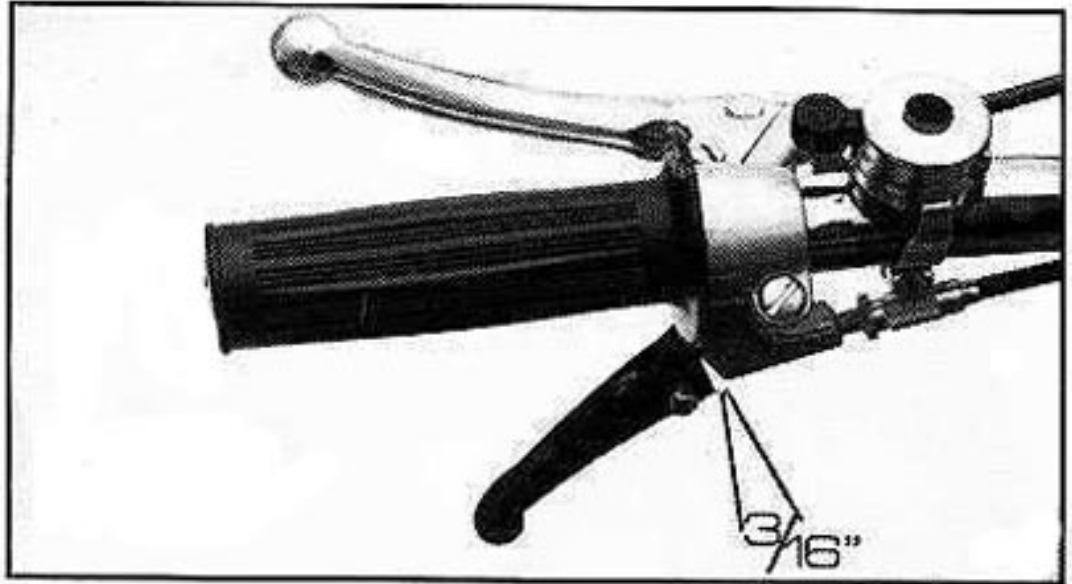

Illustration 4

Adjustment of brakes

The brake levers on the handlebar are equipped with adjusters, with which the cables can be adjusted for maximum efficiency. Allow 1.0" (abt. 2.5 cm) lever free play, measured at the lever tip, before the brakes are applied.

Chain tensioning

The right side (pedal) chain is kept to the right tension by means of an automatic tensioner. Total up and down movement of the left side (driving) chain should not exceed $3/4''$ or 20 mm ($3/8''$ or 10 mm upwards and $3/8''$ 10 mm downwards). If this movement is exceeded, the chain should be tightened by releasing the rear axle nuts and pulling the rearwheel backwards by means of both nut-keys situated at the end of the rearfork. See that the wheel remains exactly in the center of the rear fork. Afterwards the axle nuts must be securely tightened again.

Automatic chain tensioner

This chain tensioner has to run in the center of the chain-line, thus preventing the chain from running off. Check from time to time.

V-belt

Also the tension of the V-belt has to be checked from time to time. With the right tension the belt can be moved upwards and downwards $3/16''$ (abt. 5 mm) and prevents it slipping in the pulley (belt too slack) or causing wear and tear on the bearings (belt too taut).

Adjustment of V-belt tension

First release the nuts of the engine support bolts. By turning on the adjusting bolt at the left (see Ill. 5), the engine can be moved forward. Do not forget to tighten the lock-nut of the adjusting bolt and the nuts of the engine support bolts afterwards!

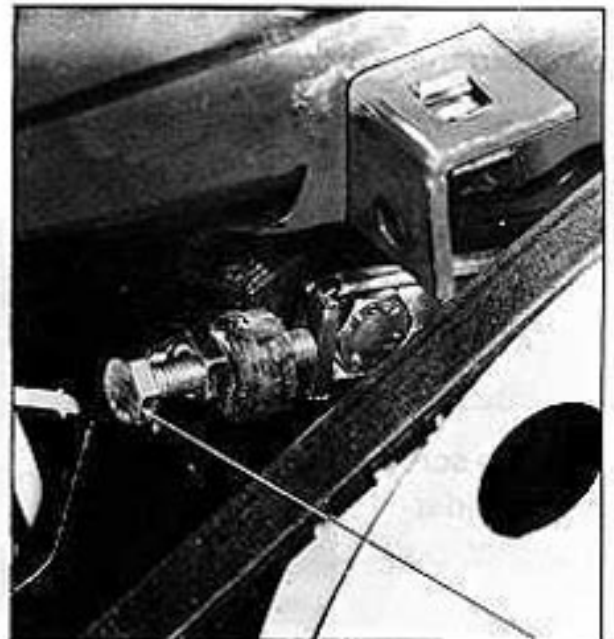
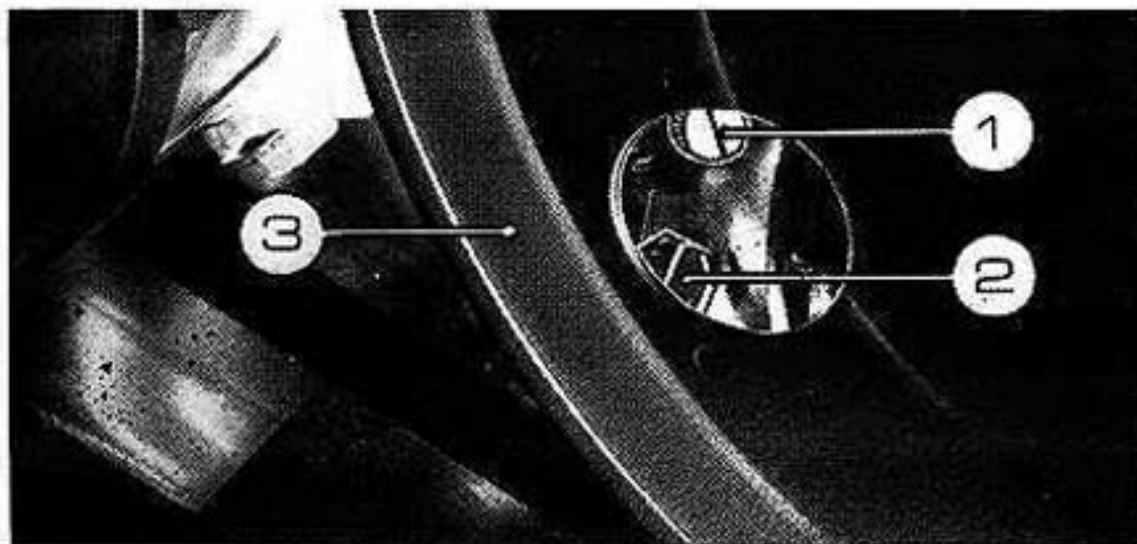

Illustration 5

Stationary running (Idling)

Take care that the engine idle speed is not too high when the moped is stationary. If it is, the automatic clutch can start to engage and drive your moped, even when the throttle is closed. The right carburetor idle adjustment avoids trouble. Adjustment is as follows: one of the holes in the pulley must be turned in such a way the adjustment screw to the right or to the left the exact adjustment can be found. (see Ill. 6).



- 1. idling screw
- 2. jet holder
- 3. pulley

Illustration 6

Gas/oil mixture

The gas must be mixed with a quality 2 stroke engine oil. The fuel should be mixed in a can to ensure proper mixing. Use the graph to arrive at an amount of oil to be mixed with the gas you have. If you plan to travel long distances, you can take a small container of oil with you. It should be premeasured so you know how much gas to add to the oil you have with you.

If absolutely necessary, you can mix the fuel in the tank. Follow these instructions when anticipating a mid-trip refueling where you will mix the gas in the tank.

- I. Calculate the amount of oil required for a full tank of 50:1 mixture. This will ensure adequate lubrication in the event of uneven mixing.
- II. Add about one (1) quart (.25 gal.) of gas to your tank.
- III. Pour in the oil (whatever volume is necessary, up to 2.50 or 3.60 oz.). Try to distribute the oil equally to each side of the tank.
- IV. Replace the tank cap.
- V. Straddle the bike, take it off its stand and rock the bike from side to side. This will slosh the fuel and mix the oil.
- VI. Remove the cap and fill up the tank.

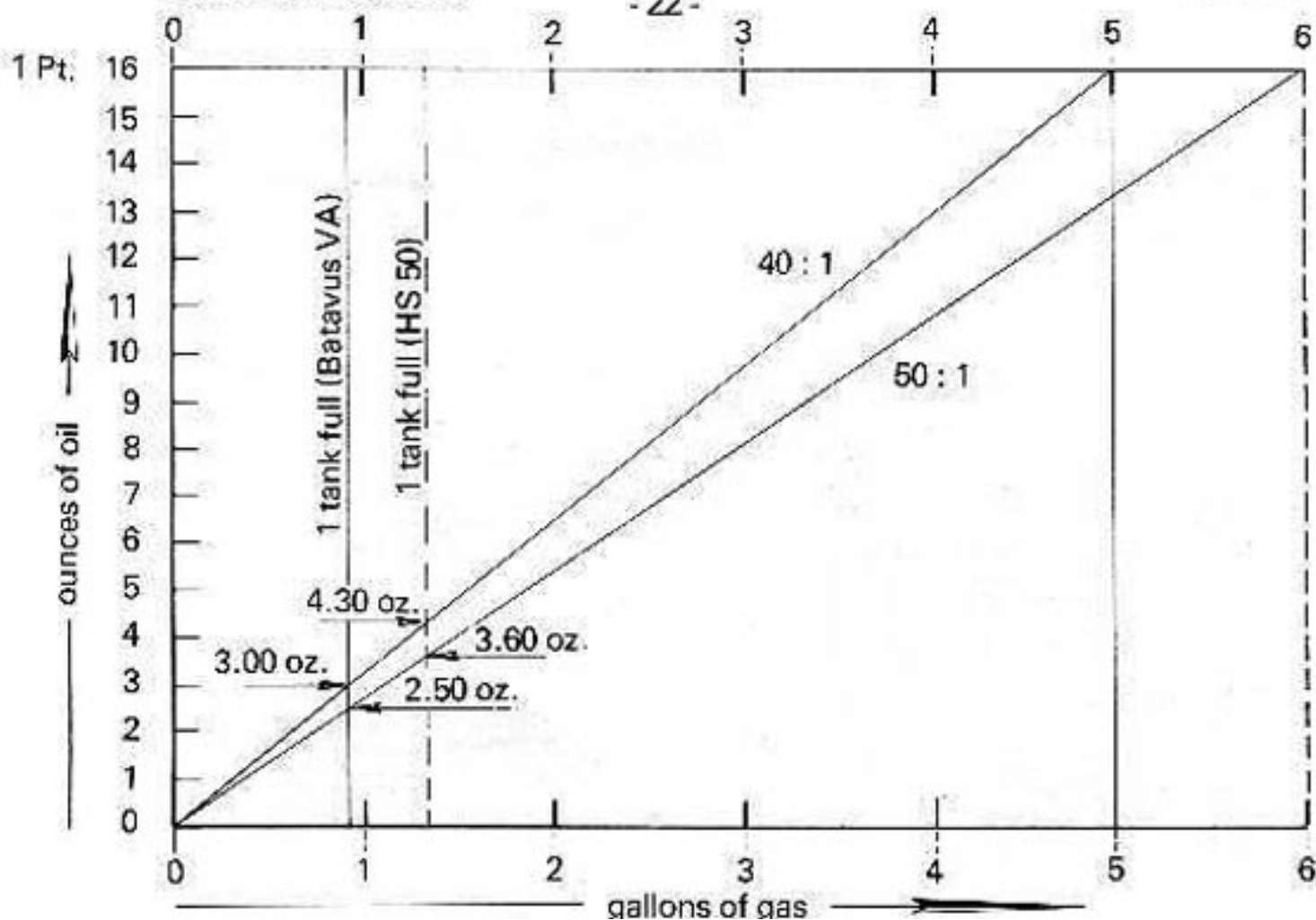

MOPED SET UP

1. Remove the bike from it's box, set on stand.
2. Disassemble one of the fastening bolts of the headlamp and pull cables through between the headlamp and the headlamp bracket.
3. Lubricate and adjust all cables. Allow 1" brake lever movement before brakes become applied. Make sure wires do not protrude from starter lever.
4. Remove wooden buffer from frontfork and install the crownplate with handlebar on the frontfork with 2 closed nuts and 2 lockrings.
5. Shift exhaust muffler over exhaust part.
Place muffler-clip around muffler and fasten it with bolt M6 x 30, lockring M6, springring M6 and nut M6.
6. Remove plastic cap from the left bracket axle end. Install leftside and rightside crank to crankaxle with cotters, lockring M7 and nuts M7 supplied.

7. Install foot pedals. The left pedal has left hand threads and is marked "L". The right pedal has right hand threads and is marked "R". Use 15 mm open end wrench or 6 mm Allen wrench to tighten pedals.
8. Remove wooden buffer from down fuel tank-lip and fasten this lip with bolt M6 x 12 supplied.
9. Install engine covers with the 4 springs supplied.
10. Install seat and fasten it with the 4 bolts MB x 20, the lockrings and the 2 fastening brackets supplied.
11. Install taillight bulb and lens.
12. Mix the gas and oil. Break-in ratio is 40:1, or 2.5%. After 500 miles a mixture 50:1 or 2% is acceptable if a high quality 2 stroke oil is used.
13. Standard tire pressure is 28 lbs per square inch front, and 34 lbs per square inch rear. Persons over 175 lbs should add 2 lbs pressure per square inch.
14. Run the engine and test the brakes and automatic clutch. Idle speed is not critical yet. Make sure that the running gear is all working. Carefully road test the cycle and set idle speed so that clutch does not drag at idle (also see page 20).

SOME ADVICE FOR WINTER STORAGE

In case you do not use your moped for a long period during winter, it is advisable to take the following precautions:

1. Close fuel tap when the engine is still running, so that the fuel in the carburetor is completely consumed.
2. Remove spark plug from cylinder head.
3. Pour 2 or 3 spoons of anti-corrosion oil into the plug hole, pedal a few times with pulled start lever, so that the engine is turned over several times. Fit spark plug again.
4. Clean cooling fins of cylinder with a steel brush.
5. Either fill tank completely with the right gas/oil mixture or empty it and rinse it with pure petrol and swill the inside of the fuel tank with anti-corrosion oil
6. Clean your moped decently; provide chromed parts with acid-free vaseline and enamelled parts with wax.

7. Inflate tyres to the correct pressure.
8. Store your moped in a dry and cool place.

Do **not** start the engine during the period of storage. When the time comes to use your moped again, the fuel tank has to be rinsed with pure petrol to remove the anti-corrosion oil.

STANDARD WARRANTY CONDITIONS FOR THE FIRST OWNERS OF BATAVUS MOPEDS.

Batavus USA, Inc., TUCKER, Georgia guarantees the moped, described on page 2 and 3 of this manual, to be free of faults of material and craftsmanship to the first owner. The warranty period is one year for all parts, excluding those mentioned hereafter. The warranty period starts from the date of purchase.

Chains, chainwheels, electric bulbs, spark plugs, ballbearings, stands, bowden cables and normal wear and tear, are excluded from this warranty.

NO WARRANTY CLAIMS WILL BE ACCEPTED IF:

- a) the moped has been subjected to misuse, negligence, abuse or accident.
- b) any repair work has been carried out by any person or firm other than an authorised Batavus dealer.
- c) the moped or engine serial number upon the moped has been so removed or defaced as to be illegible or incomplete.
- d) the first owner cannot produce the warranty card or if this card has been uncompletely or uncorrectly filled in, or if the warranty registration has not been sent in within 8 days after date of purchase.

Any original part that is judged by the importer to be defective under the terms of this warranty will be replaced free of charge. Dealer's labor costs or transportation charges

are not covered by this warranty.

Under no circumstances the manufacturer and/or Batavus USA, Inc. shall be liable on any implied warranty of merchantability or fitness or for special or consequential damage. This warranty excludes all other warranties not expressly named herein.

By signing the warranty card the first owner acknowledges these warranty conditions to be binding.

See your Batavus dealer for any service under the Batavus warranty. If necessary write or call for assistance to:

Batavus USA, inc.

2546 N.E. Expressway

ATLANTA

Georgia 30345

Telephone (404) 325-1514

Some states do not allow limitations on how long a warranty lasts nor the exclusion or limitations of incidental or consequential damages. In these cases the above limitations or exclusion may not apply to you.

This warranty gives you specific legal rights. You may also have other rights which vary from state to state.

EXPLODED VIEW OF LAURA M48 ENGINE

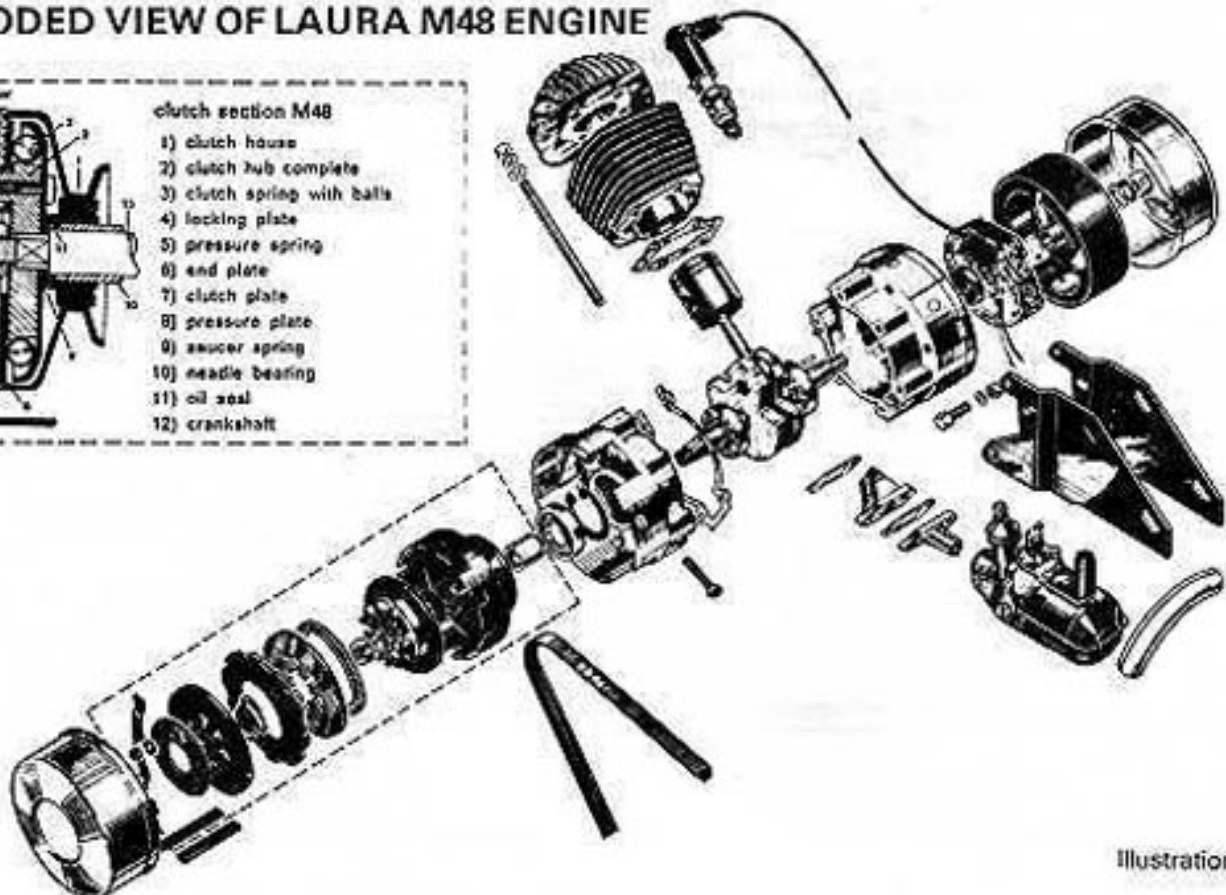
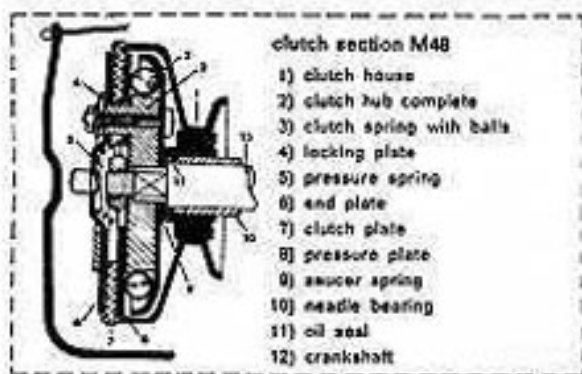

Illustration 8

WIRING DIAGRAM

- | | |
|----------------|--------------|
| 1 red | 6 greenblack |
| 2 blue | 7 brown |
| 3 green | 8 black |
| 4 green yellow | 9 white |
| 5 yellow | 10 grey |

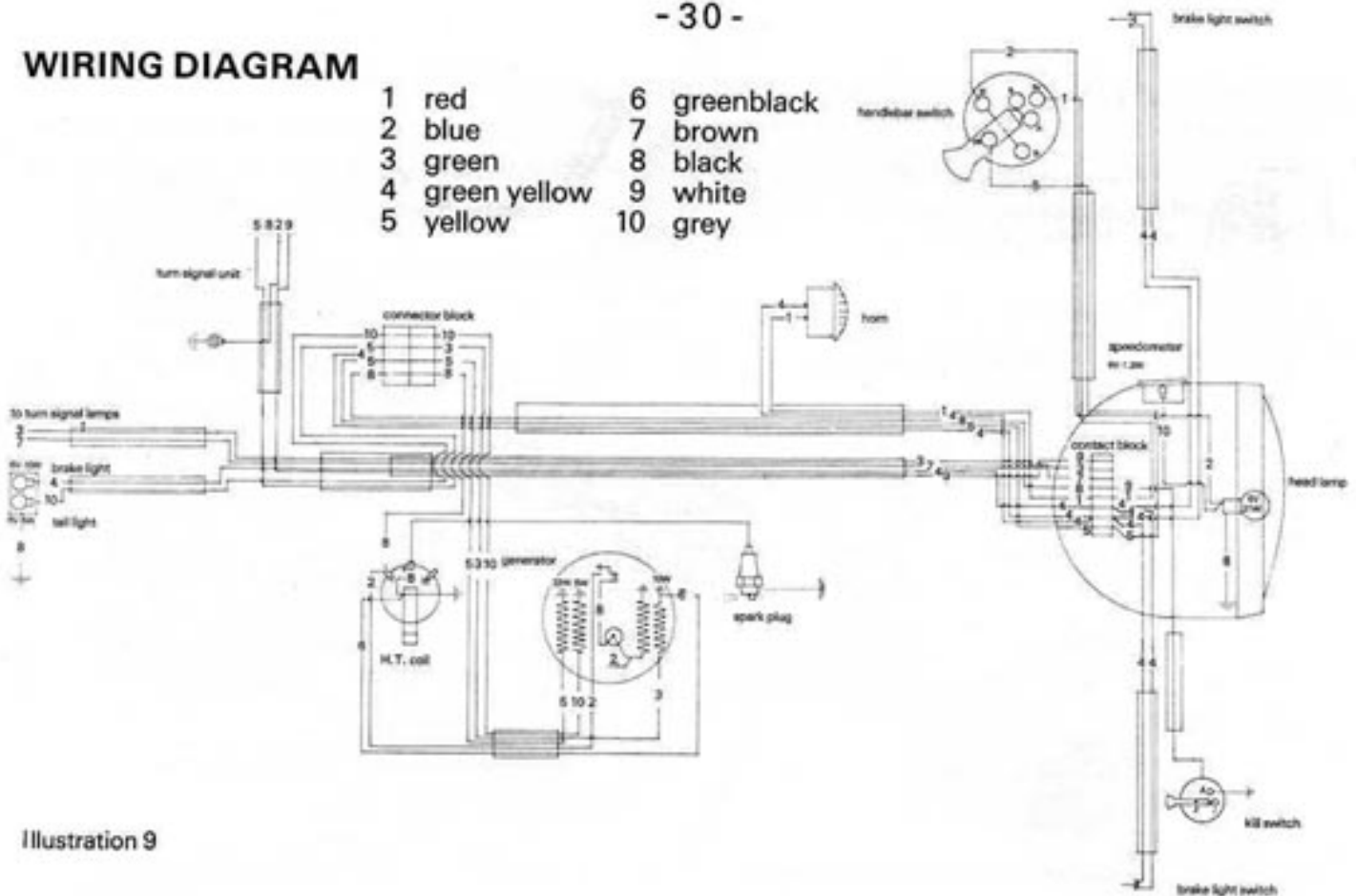
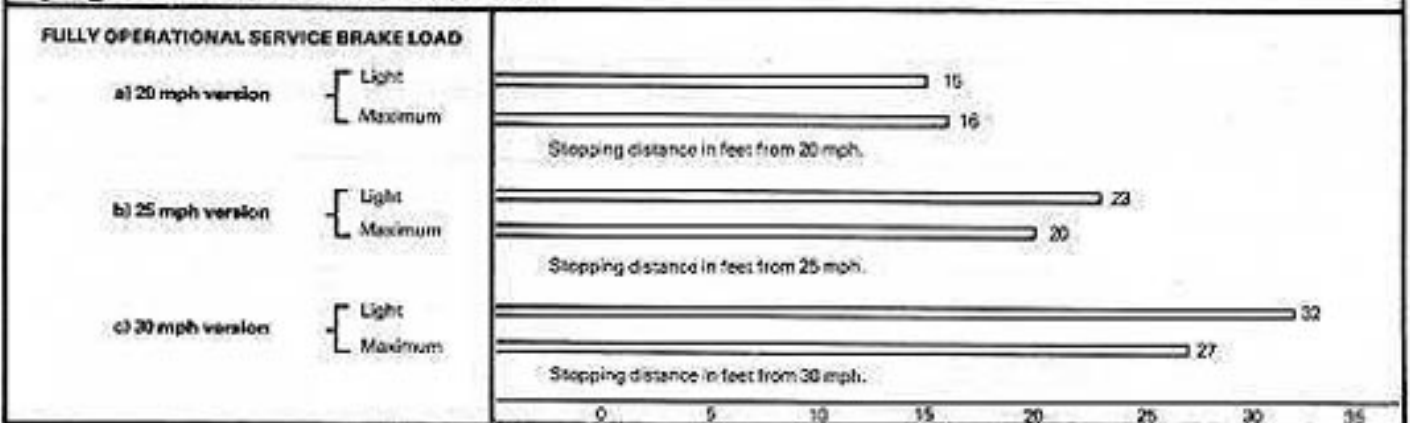

Illustration 9

CONSUMER INFORMATION

This figure indicates braking performance that can be met or exceeded by the vehicles to which it applies, without locking the wheels, under different conditions of loading. The information presented represents results obtainable by skilled drivers under controlled road and vehicle conditions, and the information may not be correct under other conditions.

Description of vehicles to which this table applies: **mopeds, as specified on pages 2 and 3 of this manual.**



Ill. 10

Notice: The above indicated stopping distances at light loading (290 lbs, incl. vehicle weight) are limited by the locking point of time of the wheels. The table also shows

that the maximum loading (350 lbs, incl. vehicle weight) has a reverse effect in this respect.

This figure indicates passing times and distances that can be met or exceeded by the vehicles to which it applies, in the situations diagrammed below. The passes indicated below assume an initial speed of 20 mph and limiting speed of 25, resp. 30 mph. The information presented represents results obtainable by skilled drivers under controlled road and vehicle conditions, and the information may not be correct under other conditions.

Description of vehicles to which this table applies: **mopeds, as specified on pages 2 and 3 of this manual.**

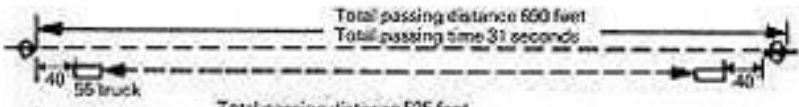
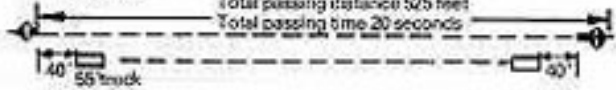
20 mph version:	not applicable		Summary table not applicable
25 mph version:		Total passing distance 690 feet Total passing time 31 seconds	Pass: 690 ft.; 31 sec.
30 mph version:		Total passing distance 525 feet Total passing time 20 seconds	Pass: 525 ft.; 20 sec.

III. 11